

- Casted body and bonnet
- Bolted bonnet (BB)
- Rising stem (RS), outside screw and yoke (OS&Y)
- Wedge may be one-piece flexible, solid or split wedge type

APPLICATIONS

- Refining
- Petrochemical
- Chemical
- Power plant



BENEFITS OF USE

- Long service life
- Respect to emission standards
- Easy handling and maintenance

TECHNICAL DATA

Media:	Depending on the gate valve materials: water, steam, gas, oil and oil derivatives and other non aggressive media
Pressure and temperature:	Pressure up to 160 bar Temperature up to 600 °C
Materials:	Carbon, heat resistant alloys and stainless steels
Options:	Electric, hydraulic or pneumatic actuator Position indicator Extended stem Locking device Non rising stem and solid wedge Hole in the wedge (overpressure safety design) Spring loaded stuffing box (SLSB) With bypass Valve With equalizing pipe With equalizing pipe and bypass valves Flanges and welding ends according to: ASME, DIN, GOST, etc. Other paint finishes are available upon customer's request Gate valve complete with counter flanges, bolting and gaskets.
Testing:	Every produced gate valve was tested according to EN 12266

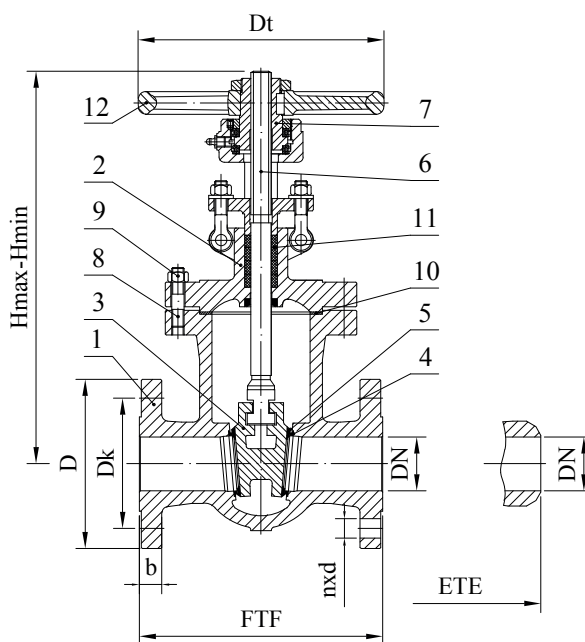

LIST OF MATERIALS

Item	Part	Material Group acc. to EN 12516-1					
		3E0	4E0	5E0	6E0	11E0	14E0
		Application					
		up to 400 °C	up to 550 °C	up to 550 °C	up to 600 °C	-196 °C ÷ 600 °C	-196 °C ÷ 600 °C
1	Body ¹⁾	1.0619	1.5419	1.7357	1.7379	1.4308	1.4408
2	Bonnet ¹⁾	1.0619	1.5419	1.7357	1.7379	1.4308	1.4408
3	Wedge ¹⁾	1.0619	1.5419	1.7357	1.7379	1.4308	1.4408
4	Body welded on with	13 Cr	13 Cr (up to 450 °C) or Stellite			Basic material or Stellite	
5	Wedge welded on with	13 Cr	13 Cr (up to 450 °C) or Stellite			Basic material or Stellite	
6	Stem	1.4021 / 1.4122				1.4301	1.4571
7	Stem Nut	1.0715 / 1.7225				Cu alloy	
8	Stud Bolts	A193 B7 / 1.7225		A193 B16 / 1.7709		A193 B8 / 1.4301	A193 B8M / 1.4401
9	Nuts	A194 2H / 1.1191		A194 4 / 1.7709		A194 8 / 1.4301	A194 8M / 1.4401
10	Bonnet Gasket	reinforced pure graphite					
11	Stem Packing	graphite with corrosion inhibitor					
12	Handwheel	steel					

1) other materials available according to EN standard

STANDARDS

Gate Valves according to EN 1984	PN16 / PN25	PN40 / PN63 / PN100 / PN160
Face-to face dimensions according to	EN 558, Serie 15	EN 558, Serie 26 or Manufacturer standard
Flanged ends according to	EN 1092-1, Tip B1	
End-to-end dimensions according to	EN 12982, Serie 15	EN 12982, Serie 26 or Manufacturer standard
Welding ends according to	EN 12627	

DIMENSIONS GEN PN16

DN		50	65	80	100	125	150	200	250	300	350	400	500	600
[mm]	FTF/ETE	250	270	280	300	325	350	400	450	500	550	600	700	800
	D	165	185	200	220	250	285	340	405	460	520	580	715	840
	Dk	125	145	160	180	210	240	295	355	410	470	525	650	770
	b	18	18	20	20	22	22	24	26	28	30	32	44	54
	nxd	4×18	⁽²⁾ ×18	8×18	8×18	8×18	8×22	12×22	12×26	12×26	16×26	16×30	20×33	20×36
	Hmax	455	515	555	664	757	945	1133	1318	1560	1720	1910	2325	2868 ⁽⁴⁾
	Hmin	385	431	459	544	622	765	903	1058	1250	1335	1481	1797	2223 ⁽⁴⁾
	Dt	250	250	250	250	315	315	400	500	500	500	630	730	500 ⁽³⁾
kg	FTF	28	37	48	50	79	85	134	245	330	580	590	1000	1650
	ETE	25	29	38	43	69	74	123	212	381	480	510	880	1400

DIMENSIONS GEN PN25

DN		50	65	80	100	125	150	200	250	300	350	400	500	600
[mm]	FTF/ETE	250	270	280	300	325	350	400	450	500	550	600	700	800
	D	165	185	200	235	270	300	360	425	485	555	620	730	845
	Dk	125	145	160	190	220	250	310	370	430	490	550	660	770
	b	20	22	24	24	26	28	30	32	34	38	40	48	58
	nxd	4×18	8×18	8×18	8×22	8×26	8×26	12×26	12×30	16×30	16×33	16×36	20×36	20×39
	Hmax	455	515	555	664	757	945	1133	1318	1560	1720	1910	2325	2868 ⁽⁴⁾
	Hmin	385	431	459	544	622	765	903	1058	1250	1335	1481	1797	2223 ⁽⁴⁾
	Dt	250	250	250	250	315	400	400	500	500	500	630	730	500 ⁽³⁾
kg	FTF	29	37	49	68	84	130	193	300	445	580	670	1025	1700
	ETE	22	33	40	57	75	93	164	264	381	530	620	880	1400

DIMENSIONS GEN PN40

DN		50	65	80	100	125	150	200	250	300	350	400	450	500	600
[mm]	FTF/ETE	250	290	310	350	400	450	550	650	750	850	950	914	1150	1350
	D	165	185	200	235	270	300	375	450	515	580	660	685	755	890
	Dk	125	145	160	190	220	250	320	285	450	510	585	610	670	795
	b	20	22	24	24	26	28	34	38	42	46	50	50	57	72
	nxd	4×18	8×18	8×18	8×22	8×26	8×26	12×30	12×33	16×33	16×38	16×39	20×39	20×42	20×48
	Hmax	470	520	571	671	775	915	1123	1430	1624	1747	1888	2160 ⁽⁴⁾	2275 ⁽⁴⁾	2738 ⁽⁴⁾
	Hmin	395	440	478	551	641	750	907	1125	1292	1372	1481	1690 ⁽⁴⁾	1764 ⁽⁴⁾	2123 ⁽⁴⁾
	Dt	250	250	250	250	400	400	500	500	500	630	730	400 ⁽³⁾	500 ⁽³⁾	630 ⁽³⁾
kg	FTF	34	53	49	77	146	167	267	410	555	860	1200	1420	1820	2200
	ETE	32	49	44	66	103	152	135	374	490	820	1095	1120	1486	1700

DIMENSIONS GEN PN63

DN		50	65	80	100	125	150	200	250	300	350	400	450	500
[mm]	FTF/ETE	250	290	310	350	400	450	550	650	750	762	950	914	1150
	D	180	205	215	250	295	345	415	470	530	600	670	715	800
	Dk	135	160	170	200	240	280	345	400	460	525	585	630	705
	b	26	26	28	30	34	36	42	46	52	56	60	64	68
	nxd	4×22	8×22	8×22	8×26	8×30	8×33	12×36	12×36	16×36	16×39	16×42	20×42	20×48
	Hmax	455	520	557	631	773	889	1102	1459	1649	1742	1888 ⁽⁴⁾	2160 ⁽⁴⁾	2410 ⁽⁴⁾
	Hmin	385	440	465	520	630	726	875	1146	1307	1362	1481 ⁽⁴⁾	1690 ⁽⁴⁾	1900 ⁽⁴⁾
	Dt	250	250	250	315	400	500	500	630	630	630	500 ⁽³⁾	630 ⁽³⁾	630 ⁽³⁾
kg	FTF	42	53	68	83	152	197	319	643	940	880	1234	1480	2800
	ETE	40	49	61	67	120	166	282	563	813	720	110	1120	2685

3) Operated by gearbox 4) Hight without actuator

DIMENSIONS GEN PN100

DN		50	65	80	100	125	150	200	250	300	350	400	500
[mm]	FTF	250	290	310	350	400	450	550	650	750	850	991	1150
	D	195	220	230	265	315	355	430	505	585	655	715	870
	Dk	145	170	180	210	250	290	360	430	500	560	620	760
	b	30	34	36	40	40	44	52	60	68	74	78	94
	nxd	4×26	8×26	8×26	8×30	8×33	12×33	12×36	12×39	16×42	16×48	16×48	20×56
	Hmax	470	520	570	676	775	926	1128	1405	1638	1910 ⁽⁴⁾	2180 ⁽⁴⁾	2410 ⁽⁴⁾
	Hmin	395	440	476	556	641	764	912	1145	1307	1530 ⁽⁴⁾	1750 ⁽⁴⁾	1900 ⁽⁴⁾
	Dt	250	250	250	315	400	500	500	730	730	500 ⁽³⁾	500 ⁽³⁾	630 ⁽³⁾
kg	FTF	44	55	70	110	164	239	419	675	1000	1250	1540	2892
	ETE	40	42	55	92	124	205	328	590	813	846	1020	2685

DIMENSIONS GEN PN160

DN		50	65	80	100	150	200	250	300
[mm]	FTF	368	419	390	450	600	750	838	965
	D	195	220	230	265	355	430	515	585
	Dk	145	170	180	210	290	360	430	500
	b	30	34	36	40	50	60	68	78
	nxd	4×26	8×26	8×26	8×30	12×33	12×36	12×42	16×42
	Hmax	540	6583	630	745	976	1164	1448 ⁽⁴⁾	1605 ⁽⁴⁾
	Hmin	466	576	535	626	785	948	1168 ⁽⁴⁾	1305 ⁽⁴⁾
	Dt	315	400	400	400	500	630	500 ⁽³⁾	500 ⁽³⁾
kg	FTF	70	117	101	162	335	596	939	1405
	ETE	51	95	78	131	250	450	716	1100

3) Operated by gearbox 4) Height without actuator

RANGE OF APPLICATION

Material	PN	Pressure (bar)/temperature (°C) ratings according to EN 12516-1																						
		-10	20	50	100	150	200	250	300	350	375	400	425	450	470	475	480	500	510	525	550	575	600	
1.0619	16	16,0	16,0	16,0	15,0	14,2	13,4	12,3	11,1	10,4	10,0	9,6												
	25	25,0	25,0	25,0	23,4	22,2	21,0	19,2	17,4	16,2	15,6	15,0												
	40	40,0	40,0	40,0	37,4	35,5	33,6	30,7	27,8	25,9	25,0	24,0												
	63	63,0	63,0	63,0	59,0	55,9	52,9	48,4	43,8	40,8	39,3	37,8												
	100	100,0	100,0	100,0	93,6	88,8	84,0	76,8	69,6	64,8	62,4	60,0												
	160	160,0	160,0	160,0	149,8	142,1	134,5	122,9	111,4	103,7	99,9	96,0												
1.5419	16	16,0	16,0	16,0	16,0	15,7	14,6	13,6	12,7	11,9	11,7	11,5	11,1	10,7	10,5	10,4	10,4	7,3	6,3	4,5	2,6			
	25	25,0	25,0	25,0	25,0	24,5	22,8	21,3	19,8	18,6	18,3	18,0	17,3	16,7	16,4	16,4	16,3	11,3	9,9	7,1	4,0			
	40	40,0	40,0	40,0	40,0	39,1	36,5	34,1	31,7	29,8	29,3	28,8	27,7	26,7	26,3	26,2	26,1	18,1	15,8	11,3	6,4			
	63	63,0	63,0	63,0	63,0	61,6	57,5	53,7	49,9	46,9	46,1	45,4	43,7	42,0	41,4	41,3	41,1	28,6	24,9	17,8	10,1			
	100	100,0	100,0	100,0	100,0	97,8	91,2	85,2	79,2	74,4	73,2	72,0	69,4	66,7	65,8	65,5	65,3	45,3	39,5	28,3	16,0			
	160	160,0	160,0	160,0	160,0	156,6	146,0	136,4	126,8	119,1	117,2	115,3	111,0	106,8	105,3	104,9	104,5	72,6	63,2	45,2	25,6			
1.7357	16	16,0	16,0	16,0	16,0	16,0	16,0	16,0	14,9	14,4	13,7	13,1	12,6	12,0	11,8	11,6	10,0	8,9	7,3	4,7				
	25	25,0	25,0	25,0	25,0	25,0	25,0	25,0	23,3	22,4	21,3	20,4	19,7	18,7	18,5	18,1	15,6	13,9	11,5	7,3				
	40	40,0	40,0	40,0	40,0	40,0	40,0	40,0	37,3	35,9	34,1	32,7	31,5	29,9	29,5	28,9	25,0	22,3	18,3	11,7				
	63	63,0	63,0	63,0	63,0	63,0	63,0	63,0	58,7	56,5	53,8	51,4	49,7	47,2	46,5	45,5	39,3	35,1	28,9	18,5				
	100	100,0	100,0	100,0	100,0	100,0	100,0	100,0	93,1	89,8	85,3	81,6	78,9	74,9	73,9	72,2	62,4	55,8	45,9	29,3				
	160	160,0	160,0	160,0	160,0	160,0	160,0	160,0	149,1	143,7	136,6	130,7	126,2	119,8	118,2	115,6	99,9	89,3	73,4	47,0				
1.7379	16	16,0	16,0	16,0	16,0	16,0	16,0	16,0	15,0	14,5	13,7	13,1	12,6	12,0	11,8	11,6	10,5	10,2	8,6	5,6	5,5	2,4		
	25	25,0	25,0	25,0	25,0	25,0	25,0	25,0	23,5	22,6	21,3	20,4	19,7	18,7	18,5	18,1	16,5	15,9	13,5	8,8	8,6	3,7		
	40	40,0	40,0	40,0	40,0	40,0	40,0	40,0	37,5	36,2	34,1	32,7	31,5	29,9	29,5	28,9	26,3	25,4	21,5	14,1	13,8	6,0		
	63	63,0	63,0	63,0	63,0	63,0	63,0	63,0	59,1	57,0	53,8	51,4	49,7	47,2	46,5	45,5	41,5	40,0	33,9	22,2	21,7	9,4		
	100	100,0	100,0	100,0	100,0	100,0	100,0	100,0	93,8	90,5	85,3	81,6	78,9	74,9	73,9	72,2	65,8	63,5	53,9	35,2	34,4	14,9		
	160	160,0	160,0	160,0	160,0	160,0	160,0	160,0	150,2	144,9	136,6	130,7	126,2	119,8	118,2	115,6	105,3	101,7	86,2	56,3	55,1	23,9		
1.4308	16	16,0	16,0	16,0	14,8	13,0	11,2	10,5	9,9	9,1	8,9	8,7	8,5	8,2	8,1	8,1	8,0	7,9	7,8	7,3	7,1	6,4	5,0	
	25	25,0	25,0	25,0	23,1	20,3	17,5	16,5	15,4	14,3	13,9	13,6	13,2	12,9	12,7	12,6	12,5	12,3	12,2	11,4	11,1	10,0	7,9	
	40	40,0	40,0	40,0	37,0	32,5	28,0	26,3	24,6	22,8	22,3	21,7	21,2	20,6	20,3	20,2	20,1	19,7	19,5	18,2	17,7	16,0	12,6	
	63	63,0	63,0	63,0	58,2	51,2	44,1	41,5	38,8	36,0	35,1	34,2	33,3	32,5	31,9	31,8	31,6	31,0	30,7	28,7	27,9	25,2	19,8	
	100	100,0	100,0	100,0	92,4	81,2	70,0	65,8	61,6	57,1	55,7	54,3	52,9	51,5	50,6	50,4	50,2	49,3	48,7	45,6	44,3	40,0	31,5	
	160	160,0	160,0	160,0	147,9	130,0	112,1	105,3	98,6	91,4	89,2	87,0	84,7	82,5	81,0	80,7	80,3	78,9	78,0	73,0	70,9	64,0	50,4	
1.4408	16	16,0	16,0	16,0	15,2	13,7	12,1	11,2	10,3	9,9	9,6	9,4	9,2	9,1	9,0	9,0	8,9	8,9	8,8	8,4	8,3	7,0	5,8	
	25	25,0	25,0	25,0	23,8	21,4	18,9	17,5	16,1	15,4	15,1	14,7	14,4	14,1	14,0	14,0	14,0	13,9	13,8	13,1	12,9	10,9	9,1	
	40	40,0	40,0	40,0	38,1	34,2	30,2	28,0	25,8	24,6	24,1	23,5	23,0	22,6	22,4	22,4	22,2	22,1	20,9	20,7	17,5	14,5		
	63	63,0	63,0	63,0	60,0	53,8	47,6	44,1	40,6	38,8	37,9	37,0	36,2	35,6	35,4	35,3	35,2	34,9	34,8	32,9	32,6	27,6	22,8	
	100	100,0	100,0	100,0	95,2	85,4	75,6	70,0	64,4	61,6	60,2	58,8	57,4	56,6	56,1	56,0	55,9	55,4	55,2	52,3	51,7	43,7	36,3	
	160	160,0	160,0	160,0	152,4	136,7	121,0	112,1	103,1	98,6	96,4	94,1	91,9	90,5	89,8	89,6	89,5	88,7	88,4	83,7	82,8	70,0	58,1	

OPTIONAL EXECUTION



Elastic wedge



Solid wedge



Split wedge

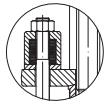

Spring loaded stuffing box (SLSB)

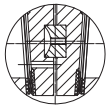

With hole in the wedge

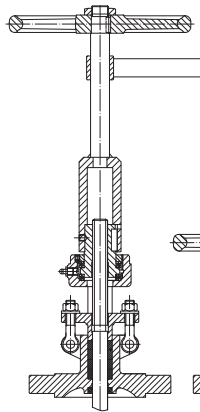

Extended stem

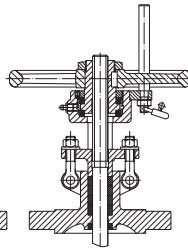

Locking device

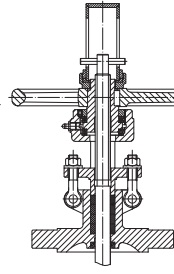

Position indicator

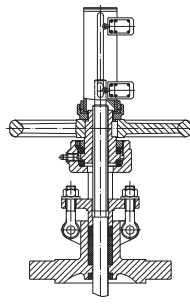

Limit switches

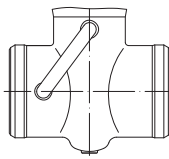

With equalizing pipe

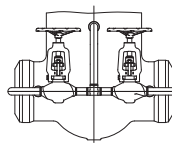

With equalizing pipe and bypass valves



Operated with chain

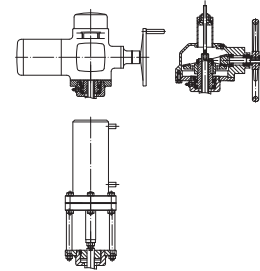

Operated by electric, pneumatic or hydraulic

The data in this datasheet are informative only and the manufacturer reserves the right to changes of technical details.